



# Low-Cost, High-Speed, SOT23, Single-Supply Op Amps with Rail-to-Rail Outputs

## General Description

The MAX4012 single, MAX4016 dual, MAX4018 triple, and MAX4020 quad op amps are unity-gain-stable devices that combine high-speed performance with Rail-to-Rail® outputs. The MAX4018 has a disable feature that reduces power-supply current to 400µA and places its outputs into a high-impedance state. These devices operate from a +3.3V to +10V single supply or from ±1.65V to ±5V dual supplies. The common-mode input voltage range extends beyond the negative power-supply rail (ground in single-supply applications).

These devices require only 5.5mA of quiescent supply current while achieving a 200MHz -3dB bandwidth and a 600V/µs slew rate. These parts are an excellent solution in low-power/low-voltage systems that require wide bandwidth, such as video, communications, and instrumentation. In addition, when disabled, their high output impedance makes them ideal for multiplexing applications.

The MAX4012 comes in a miniature 5-pin SOT23 package, while the MAX4016 comes in 8-pin µMAX and SO packages. The MAX4018/MAX4020 are available in a space-saving 16-pin QSOP, as well as a 14-pin SO.

## Applications

Set-Top Boxes  
Surveillance Video Systems  
Battery-Powered Instruments  
Video Line Driver  
Analog-to-Digital Converter Interface  
CCD Imaging Systems  
Video Routing and Switching Systems

## Typical Operating Circuit

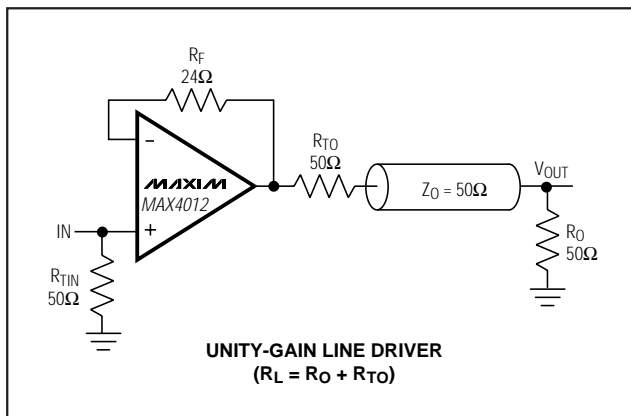

Rail-to-Rail is a registered trademark of Nippon Motorola Ltd.

## Features

- ◆ **Low-Cost**
- ◆ **High Speed:**
  - 200MHz -3dB Bandwidth (MAX4012)**
  - 150MHz -3dB Bandwidth (MAX4016/18/20)**
  - 30MHz 0.1dB Gain Flatness**
  - 600V/µs Slew Rate**
- ◆ **Single 3.3V/5.0V Operation**
- ◆ **Rail-to-Rail Outputs**
- ◆ **Input Common-Mode Range Extends Beyond V<sub>EE</sub>**
- ◆ **Low Differential Gain/Phase: 0.02%/0.02°**
- ◆ **Low Distortion at 5MHz:**
  - 78dBc SFDR**
  - 75dB Total Harmonic Distortion**
- ◆ **High Output Drive: ±120mA**
- ◆ **400µA Shutdown Capability (MAX4018)**
- ◆ **High Output Impedance in Off State (MAX4018)**
- ◆ **Space-Saving SOT23-5, µMAX, or QSOP Packages**

## Ordering Information

PART	TEMP. RANGE	PIN-PACKAGE	SOT TOP MARK
MAX4012EUK	-40°C to +85°C	5 SOT23-5	ABZP
MAX4016ESA	-40°C to +85°C	8 SO	—
MAX4016EUA	-40°C to +85°C	8 µMAX	—

Ordering Information continued at end of data sheet.

## Pin Configurations

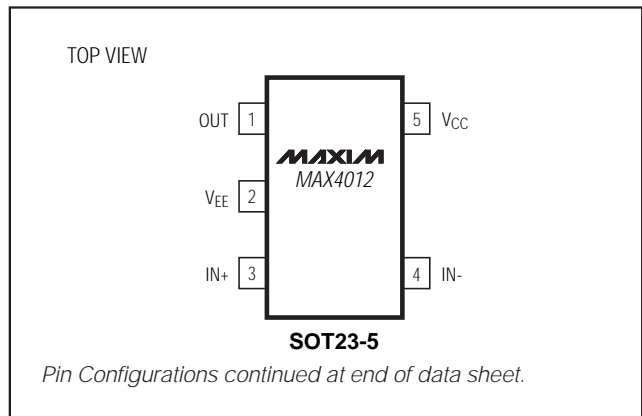

# Low-Cost, High-Speed, SOT23, Single-Supply Op Amps with Rail-to-Rail Outputs

## ABSOLUTE MAXIMUM RATINGS

Supply Voltage ( $V_{CC}$ to $V_{EE}$ ).....	+12V	8-Pin $\mu$ MAX (derate 4.1mW/°C above +70°C) .....	330mW
$IN_-$ , $IN_+$ , $OUT_-$ , $EN_-$ .....	( $V_{EE} - 0.3V$ ) to ( $V_{CC} + 0.3V$ )	14-Pin SO (derate 8.3mW/°C above +70°C) .....	667mW
Output Short-Circuit Duration to $V_{CC}$ or $V_{EE}$ .....	Continuous	16-Pin QSOP (derate 8.3mW/°C above +70°C) .....	667mW
Continuous Power Dissipation ( $T_A = +70^\circ C$ )		Operating Temperature Range .....	-40°C to +85°C
5-Pin SOT23 (derate 7.1mW/°C above +70°C) .....	571mW	Storage Temperature Range .....	-65°C to +150°C
8-Pin SO (derate 5.9mW/°C above +70°C) .....	471mW	Lead Temperature (soldering, 10sec) .....	+300°C

Stresses beyond those listed under "Absolute Maximum Ratings" may cause permanent damage to the device. These are stress ratings only, and functional operation of the device at these or at any other conditions beyond those indicated in the operational sections of the specifications is not implied. Exposure to absolute maximum rating conditions for extended periods may affect device reliability.

## DC ELECTRICAL CHARACTERISTICS

( $V_{CC} = +5V$ ,  $V_{EE} = 0V$ ,  $EN_- = +5V$ ,  $R_L = \infty$  to  $V_{CC} / 2$ ,  $V_{OUT} = V_{CC} / 2$ ,  $T_A = T_{MIN}$  to  $T_{MAX}$ , unless otherwise noted. Typical values are at  $T_A = +25^\circ C$ .) (Note 1)

PARAMETER	SYMBOL	CONDITIONS	MIN	TYP	MAX	UNITS
Input Common-Mode Voltage Range	$V_{CM}$	Guaranteed by CMRR test	$V_{EE} - 0.20$		$V_{CC} - 2.25$	V
Input Offset Voltage (Note 2)	$V_{OS}$			4	20	mV
Input Offset Voltage Temperature Coefficient	$TC_{VOS}$			8		$\mu V/^\circ C$
Input Offset Voltage Matching		Any channels for MAX4016/MAX4018/MAX4020		$\pm 1$		mV
Input Bias Current	$I_B$	(Note 2)		5.4	20	$\mu A$
Input Offset Current	$I_{OS}$	(Note 2)		0.1	20	$\mu A$
Input Resistance	$R_{IN}$	Differential mode ( $-1V \leq V_{IN} \leq +1V$ )		70		k $\Omega$
		Common mode ( $-0.2V \leq V_{CM} \leq +2.75V$ )		3		M $\Omega$
Common-Mode Rejection Ratio	CMRR	( $V_{EE} - 0.2V$ ) $\leq V_{CM} \leq (V_{CC} - 2.25V)$	70	100		dB
Open-Loop Gain (Note 2)	$A_{VOL}$	$0.25V \leq V_{OUT} \leq 4.75V$ , $R_L = 2k\Omega$		61		dB
		$0.5V \leq V_{OUT} \leq 4.5V$ , $R_L = 150\Omega$	52	59		
		$1.0V \leq V_{OUT} \leq 4V$ , $R_L = 50\Omega$		57		
Output Voltage Swing (Note 2)	$V_{OUT}$	$R_L = 2k\Omega$	$V_{CC} - V_{OH}$		0.06	V
			$V_{OL} - V_{EE}$		0.06	
		$R_L = 150\Omega$	$V_{CC} - V_{OH}$		0.30	
			$V_{OL} - V_{EE}$		0.30	
		$R_L = 75\Omega$	$V_{CC} - V_{OH}$	0.6	1.5	
			$V_{OL} - V_{EE}$	0.6	1.5	
$R_L = 75\Omega$ to ground	$V_{CC} - V_{OH}$	1.1	2.0			
	$V_{OL} - V_{EE}$	0.05	0.50			
Output Current	$I_{OUT}$	$R_L = 20\Omega$ to $V_{CC}$ or $V_{EE}$	$\pm 100$	$\pm 120$		mA
Output Short-Circuit Current	$I_{SC}$	Sinking or sourcing		$\pm 150$		mA
Open-Loop Output Resistance	$R_{OUT}$			8		$\Omega$

# Low-Cost, High-Speed, SOT23, Single-Supply Op Amps with Rail-to-Rail Outputs

## DC ELECTRICAL CHARACTERISTICS (continued)

( $V_{CC} = +5V$ ,  $V_{EE} = 0V$ ,  $EN_{-} = +5V$ ,  $R_L = \infty$  to  $V_{CC} / 2$ ,  $V_{OUT} = V_{CC} / 2$ ,  $T_A = T_{MIN}$  to  $T_{MAX}$ , unless otherwise noted. Typical values are at  $T_A = +25^{\circ}C$ .) (Note 1)

PARAMETER	SYMBOL	CONDITIONS	MIN	TYP	MAX	UNITS
Power-Supply Rejection Ratio (Note 3)	PSRR	$V_{CC} = 5V$ , $V_{EE} = 0V$ , $V_{CM} = +2.0V$	46	57		dB
		$V_{CC} = 5V$ , $V_{EE} = -5V$ , $V_{CM} = 0V$	54	66		
		$V_{CC} = 3.3V$ , $V_{EE} = 0V$ , $V_{CM} = +0.90V$		45		
Operating Supply-Voltage Range	$V_S$	$V_{CC}$ to $V_{EE}$	3.15		11.0	V
Disabled Output Resistance	$R_{OUT(OFF)}$	$EN_{-} = 0V$ , $0V \leq V_{OUT} \leq 5V$ (Note 4)	28	35		$k\Omega$
$EN_{-}$ Logic-Low Threshold	$V_{IL}$				$V_{CC} - 2.6$	V
$EN_{-}$ Logic-High Threshold	$V_{IH}$		$V_{CC} - 1.6$			V
$EN_{-}$ Logic Input Low Current	$I_{IL}$	$(V_{EE} + 0.2V) \leq EN_{-} \leq V_{CC}$		0.5		$\mu A$
		$EN_{-} = 0V$		200	300	
$EN_{-}$ Logic Input High Current	$I_{IH}$	$EN_{-} = 5V$		0.5	10	$\mu A$
Quiescent Supply Current (per Amplifier)	$I_S$	Enabled		5.5	7.0	mA
		MAX4018, disabled ( $EN_{-} = 0V$ )		0.40	0.55	

MAX4012/MAX4016/MAX4018/MAX4020

# Low-Cost, High-Speed, SOT23, Single-Supply Op Amps with Rail-to-Rail Outputs

## AC ELECTRICAL CHARACTERISTICS

( $V_{CC} = +5V$ ,  $V_{EE} = 0V$ ,  $V_{CM} = 2.5V$ ,  $EN_{-} = +5V$ ,  $R_F = 24\Omega$ ,  $R_L = 100\Omega$  to  $V_{CC} / 2$ ,  $V_{OUT} = V_{CC} / 2$ ,  $Av_{CL} = +1$ ,  $T_A = +25^{\circ}C$ , unless otherwise noted.)

PARAMETER	SYMBOL	CONDITIONS		MIN	TYP	MAX	UNITS
Small-Signal -3dB Bandwidth	BW <sub>SS</sub>	V <sub>OUT</sub> = 20mVp-p	MAX4012	200		150	MHz
			MAX4016/MAX4018/ MAX4020				
Large-Signal -3dB Bandwidth	BW <sub>LS</sub>	V <sub>OUT</sub> = 2Vp-p		140			MHz
Bandwidth for 0.1dB Gain Flatness	BW <sub>0.1dB</sub>	V <sub>OUT</sub> = 20mVp-p (Note 5)		6	30		MHz
Slew Rate	SR	V <sub>OUT</sub> = 2V step		600			V/ $\mu$ s
Settling Time to 0.1%	t <sub>s</sub>	V <sub>OUT</sub> = 2V step		45			ns
Rise/Fall Time	t <sub>R</sub> , t <sub>F</sub>	V <sub>OUT</sub> = 100mVp-p		1			ns
Spurious-Free Dynamic Range	SFDR	f <sub>C</sub> = 5MHz, V <sub>OUT</sub> = 2Vp-p		-78			dBc
Harmonic Distortion	HD	f <sub>C</sub> = 5MHz, V <sub>OUT</sub> = 2Vp-p	2nd harmonic	-78			dBc
			3rd harmonic	-82			
			Total harmonic distortion	-75			dB
Two-Tone, Third-Order Intermodulation Distortion	IP3	f <sub>1</sub> = 10.0MHz, f <sub>2</sub> = 10.1MHz, V <sub>OUT</sub> = 1Vp-p		35			dBc
Input 1dB Compression Point		f <sub>C</sub> = 10MHz, Av <sub>CL</sub> = +2		11			dBm
Differential Phase Error	DP	NTSC, R <sub>L</sub> = 150 $\Omega$		0.02			degrees
Differential Gain Error	DG	NTSC, R <sub>L</sub> = 150 $\Omega$		0.02			%
Input Noise-Voltage Density	e <sub>n</sub>	f = 10kHz		10			nV/ $\sqrt{Hz}$
Input Noise-Current Density	i <sub>n</sub>	f = 10kHz		6			pA/ $\sqrt{Hz}$
Input Capacitance	C <sub>IN</sub>			1			pF
Disabled Output Capacitance	C <sub>OUT (OFF)</sub>	MAX4018, EN <sub>-</sub> = 0V		2			pF
Output Impedance	Z <sub>OUT</sub>	f = 10MHz		6			$\Omega$
Amplifier Enable Time	t <sub>ON</sub>	MAX4018		100			ns
Amplifier Disable Time	t <sub>OFF</sub>	MAX4018		1			$\mu$ s
Amplifier Gain Matching		MAX4016/MAX4018/MAX4020, f = 10MHz, V <sub>OUT</sub> = 20mVp-p		0.1			dB
Amplifier Crosstalk	X <sub>TALK</sub>	MAX4016/MAX4018/MAX4020, f = 10MHz, V <sub>OUT</sub> = 2Vp-p, R <sub>S</sub> = 50 $\Omega$ to ground		-95			dB

**Note 1:** The MAX4012EUT is 100% production tested at  $T_A = +25^{\circ}C$ . Specifications over temperature limits are guaranteed by design.

**Note 2:** Tested with  $V_{CM} = +2.5V$ .

**Note 3:** PSR for single +5V supply tested with  $V_{EE} = 0V$ ,  $V_{CC} = +4.5V$  to  $+5.5V$ ; for dual  $\pm 5V$  supply with  $V_{EE} = -4.5V$  to  $-5.5V$ ,  $V_{CC} = +4.5V$  to  $+5.5V$ ; and for single +3.3V supply with  $V_{EE} = 0V$ ,  $V_{CC} = +3.15V$  to  $+3.45V$ .

**Note 4:** Does not include the external feedback network's impedance.

**Note 5:** Guaranteed by design.

# Low-Cost, High-Speed, SOT23, Single-Supply Op Amps with Rail-to-Rail Outputs

## Typical Operating Characteristics

( $V_{CC} = +5V$ ,  $V_{EE} = 0V$ ,  $A_{vCL} = +1$ ,  $R_F = 24\Omega$ ,  $R_L = 100\Omega$  to  $V_{CC} / 2$ ,  $T_A = +25^\circ C$ , unless otherwise noted.)

MAX4012/MAX4016/MAX4018/MAX4020

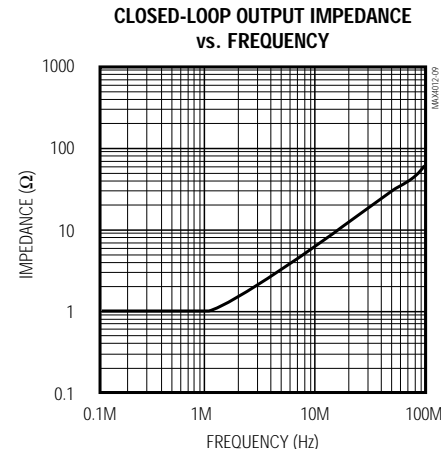
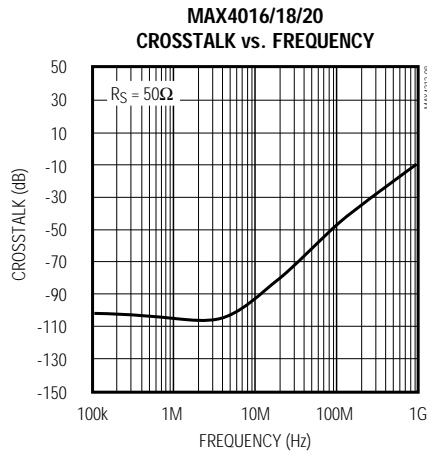
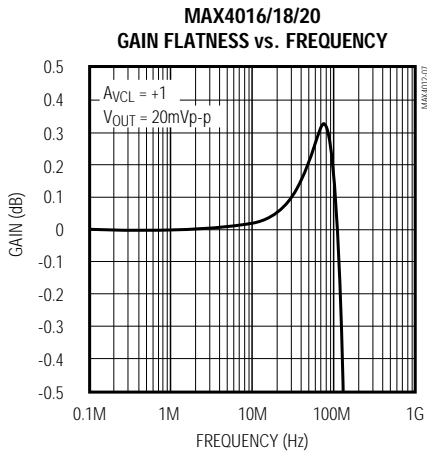
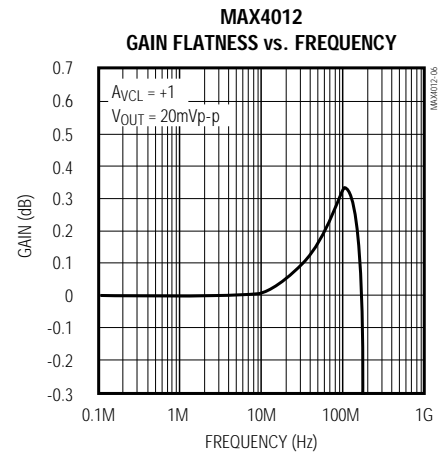
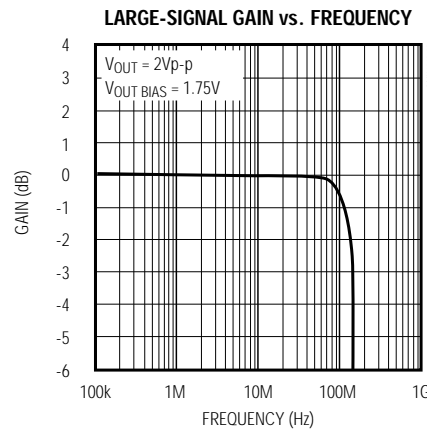
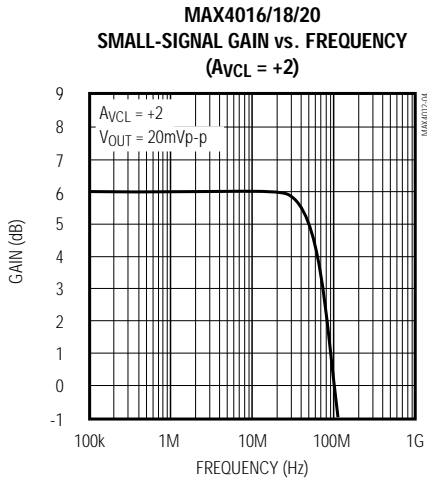
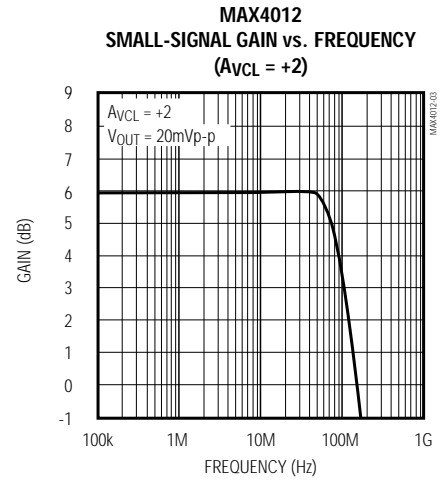
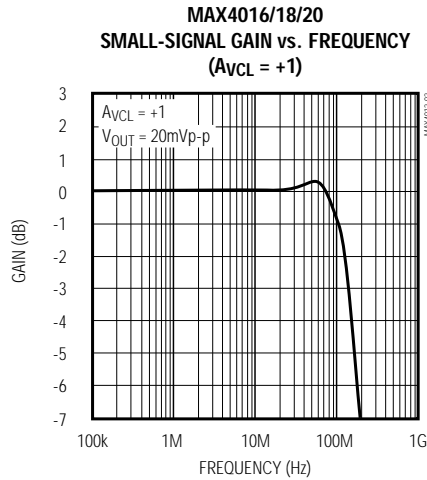
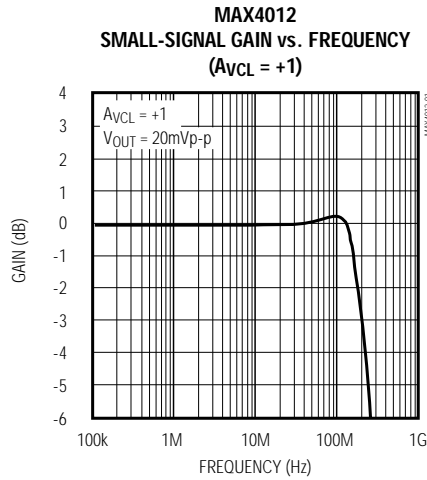

# Low-Cost, High-Speed, SOT23, Single-Supply Op Amps with Rail-to-Rail Outputs

## Typical Operating Characteristics (continued)

( $V_{CC} = +5V$ ,  $V_{EE} = 0V$ ,  $A_{VCL} = +1$ ,  $R_F = 24\Omega$ ,  $R_L = 100\Omega$  to  $V_{CC} / 2$ ,  $T_A = +25^\circ C$ , unless otherwise noted.)

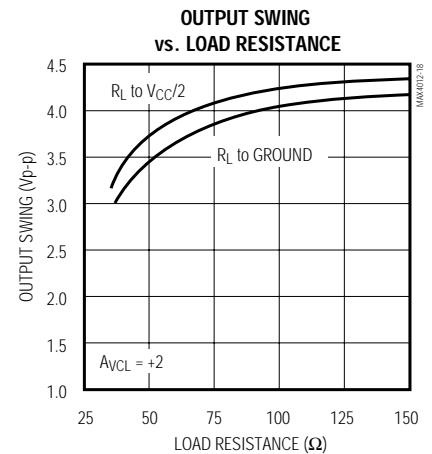
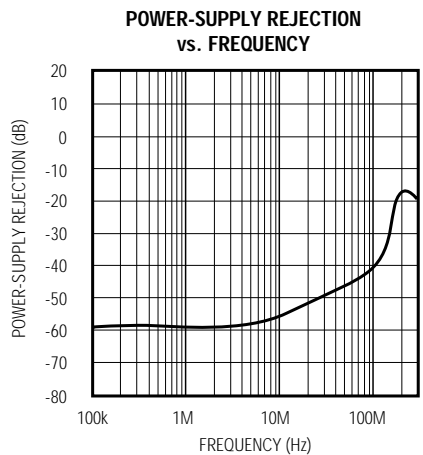
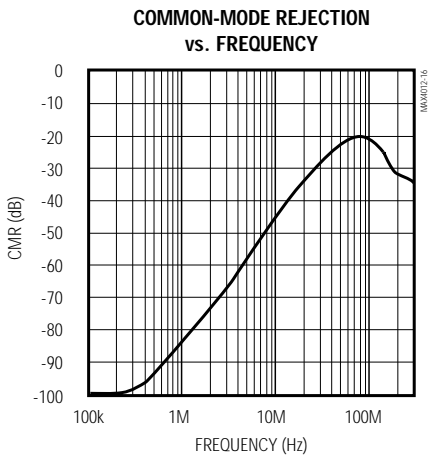
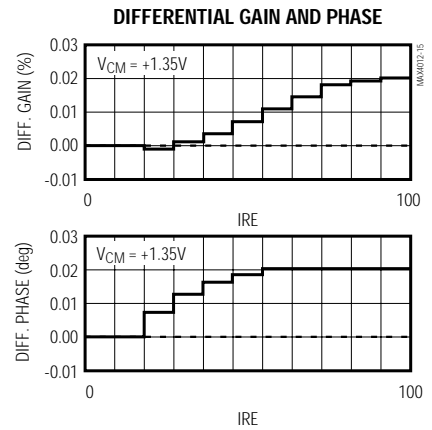
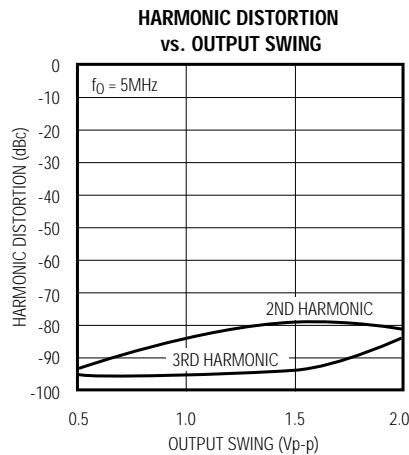
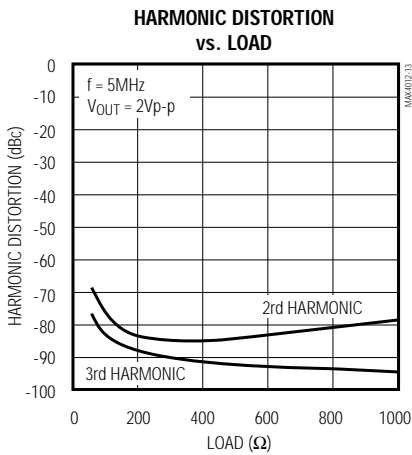
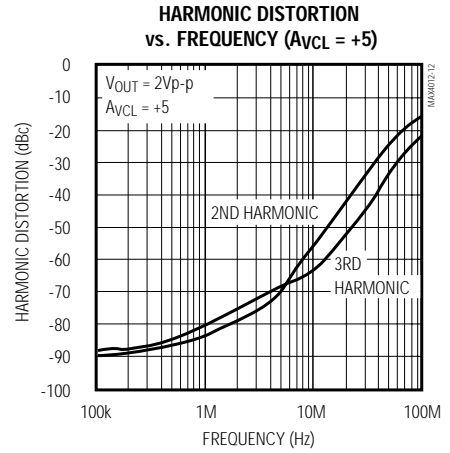
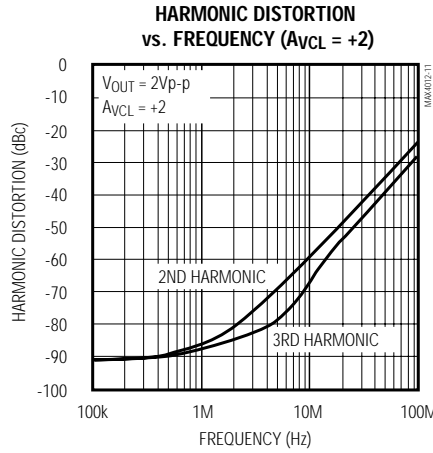
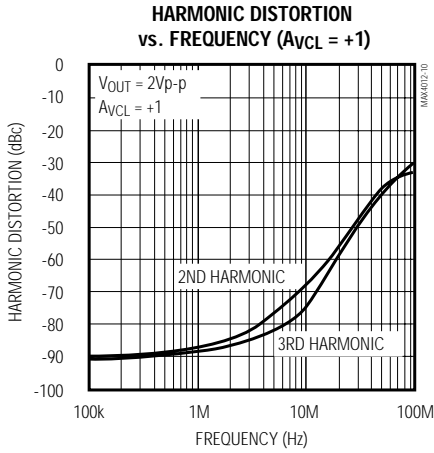

# Low-Cost, High-Speed, SOT23, Single-Supply Op Amps with Rail-to-Rail Outputs

## Typical Operating Characteristics (continued)

( $V_{CC} = +5V$ ,  $V_{EE} = 0V$ ,  $A_{vCL} = +1$ ,  $R_F = 24\Omega$ ,  $R_L = 100\Omega$  to  $V_{CC}/2$ ,  $T_A = +25^\circ C$ , unless otherwise noted.)

**SMALL-SIGNAL PULSE RESPONSE**  
( $A_{vCL} = +1$ )

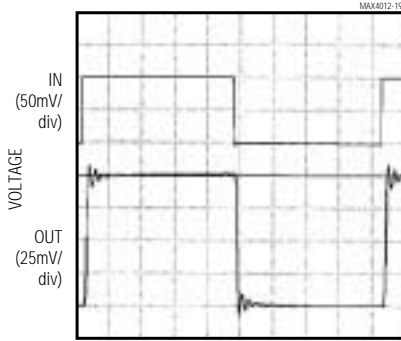

TIME (20ns/div)  
 $V_{CM} = +2.5V$ ,  $R_L = 100\Omega$  to GROUND

**SMALL-SIGNAL PULSE RESPONSE**  
( $A_{vCL} = +2$ )

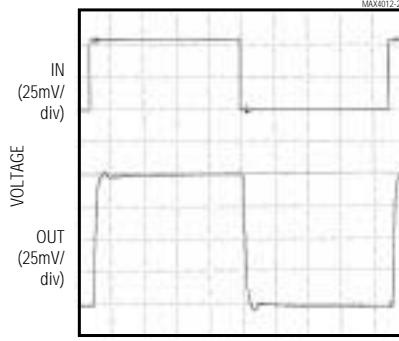

TIME (20ns/div)  
 $V_{CM} = +1.25V$ ,  $R_L = 100\Omega$  to GROUND

**SMALL-SIGNAL PULSE RESPONSE**  
( $C_L = 5pF$ ,  $A_{vCL} = +1$ )

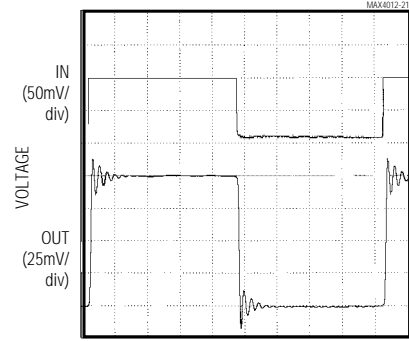

TIME (20ns/div)  
 $V_{CM} = +1.75V$ ,  $R_L = 100\Omega$  to GROUND

**LARGE-SIGNAL PULSE RESPONSE**  
( $A_{vCL} = +1$ )

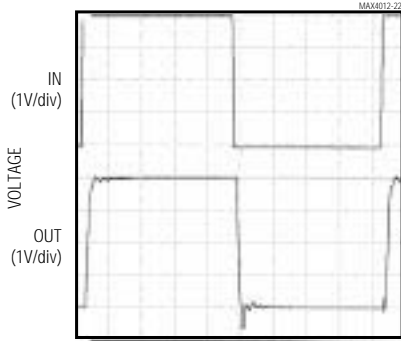

TIME (20ns/div)  
 $V_{CM} = +1.75V$ ,  $R_L = 100\Omega$  to GROUND

**LARGE-SIGNAL PULSE RESPONSE**  
( $A_{vCL} = +2$ )

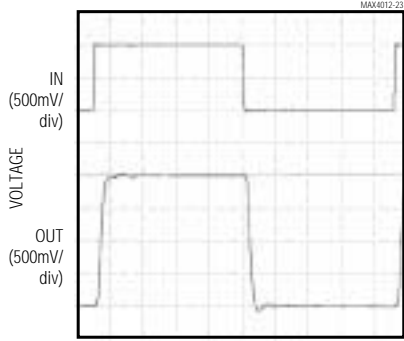

TIME (20ns/div)  
 $V_{CM} = 0.9V$ ,  $R_L = 100\Omega$  to GROUND

**LARGE-SIGNAL PULSE RESPONSE**  
( $C_L = 5pF$ ,  $A_{vCL} = +2$ )

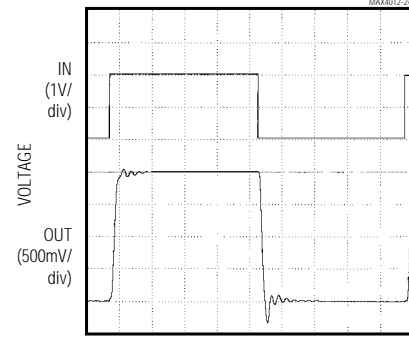

TIME (20ns/div)  
 $V_{CM} = +1.75V$ ,  $R_L = 100\Omega$  to GROUND

**VOLTAGE-NOISE DENSITY vs. FREQUENCY**

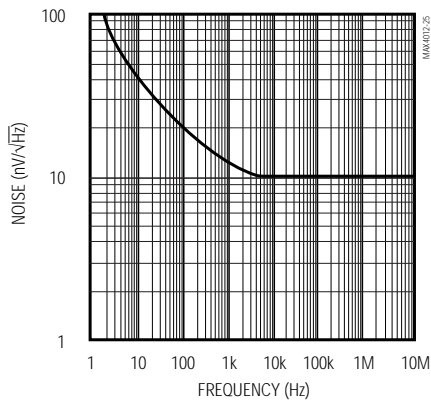

**CURRENT-NOISE DENSITY vs. FREQUENCY**

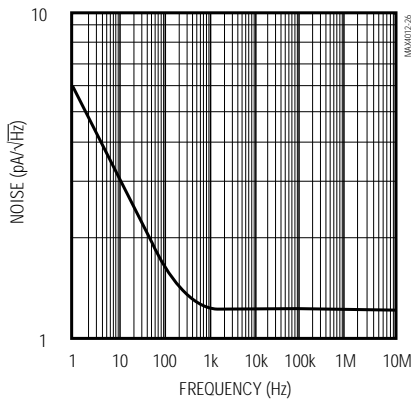

**ENABLE RESPONSE TIME**

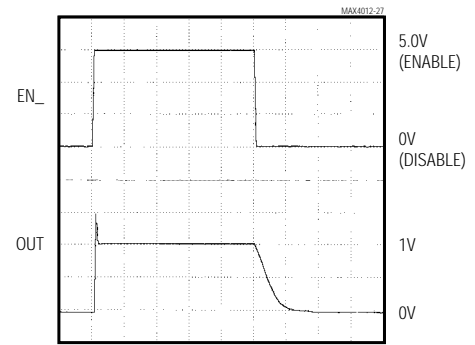

$V_{IN} = +1.0V$

MAX4012/MAX4016/MAX4018/MAX4020

# Low-Cost, High-Speed, SOT23, Single-Supply Op Amps with Rail-to-Rail Outputs

## Typical Operating Characteristics (continued)

( $V_{CC} = +5V$ ,  $V_{EE} = 0V$ ,  $A_{VCL} = +1$ ,  $R_F = 24\Omega$ ,  $R_L = 100\Omega$  to  $V_{CC} / 2$ ,  $T_A = +25^\circ C$ , unless otherwise noted.)

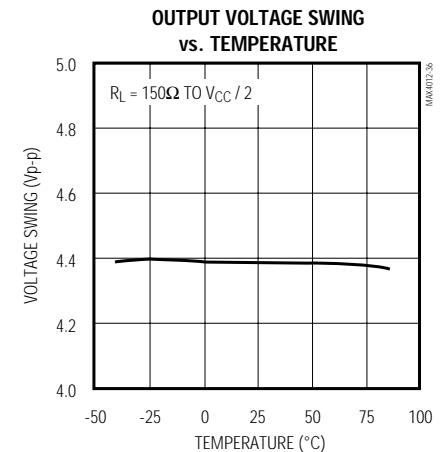
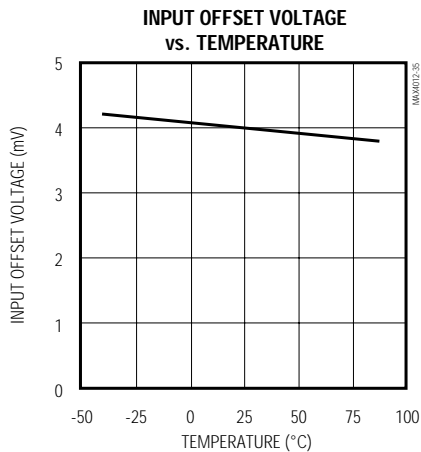
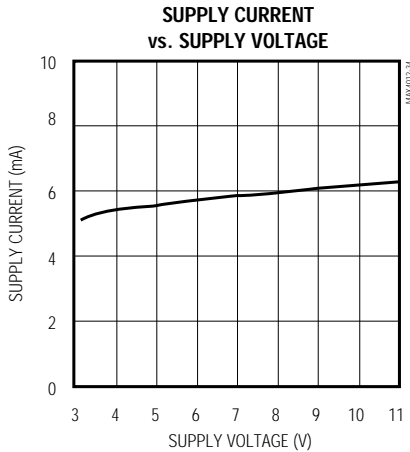
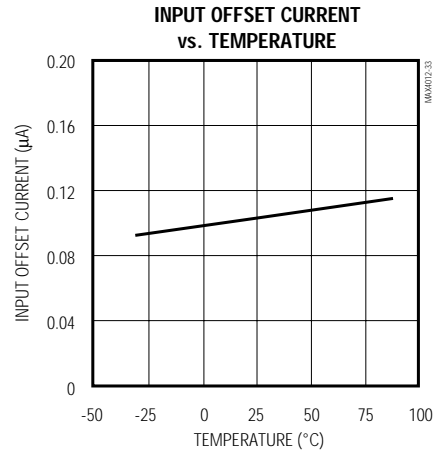
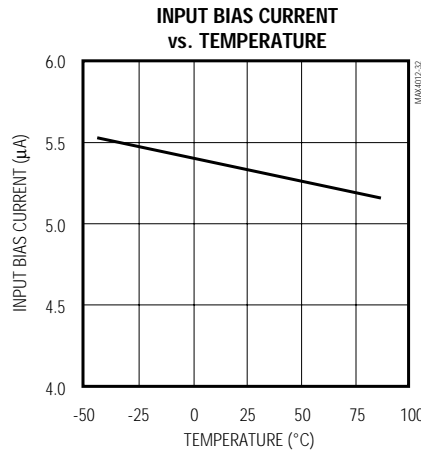
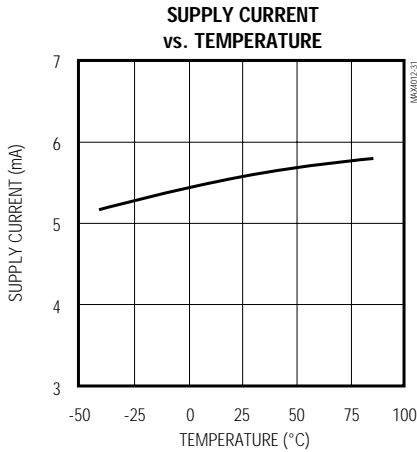
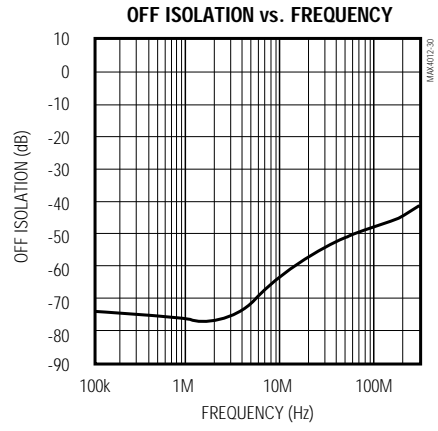
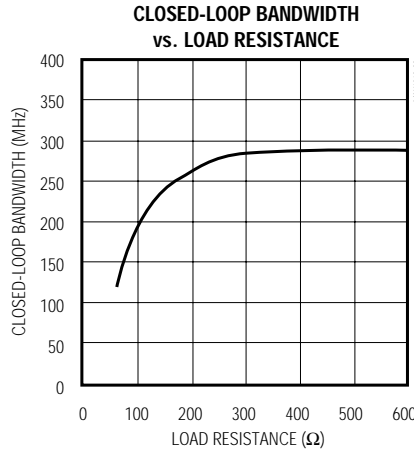
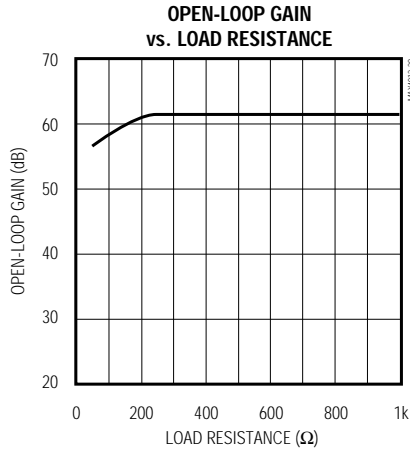



# Low-Cost, High-Speed, SOT23, Single-Supply Op Amps with Rail-to-Rail Outputs

## Pin Description

MAX4012 SOT23-5	MAX4016 SO/ $\mu$ MAX	PIN				NAME	FUNCTION
		MAX4018		MAX4020			
		SO	QSOP	SO	QSOP		
—	—	—	8, 9	—	8, 9	N.C.	No Connect. Not internally connected. Tie to ground or leave open.
1	—	—	—	—	—	OUT	Amplifier Output
2	4	11	13	11	13	VEE	Negative Power Supply or Ground (in single-supply operation)
3	—	—	—	—	—	IN+	Noninverting Input
4	—	—	—	—	—	IN-	Inverting Input
5	8	4	4	4	4	VCC	Positive Power Supply
—	1	7	7	1	1	OUTA	Amplifier A Output
—	2	6	6	2	2	INA-	Amplifier A Inverting Input
—	3	5	5	3	3	INA+	Amplifier A Noninverting Input
—	7	8	10	7	7	OUTB	Amplifier B Output
—	6	9	11	6	6	INB-	Amplifier B Inverting Input
—	5	10	12	5	5	INB+	Amplifier B Noninverting Input
—	—	14	16	8	10	OUTC	Amplifier C Output
—	—	13	15	9	11	INC-	Amplifier C Inverting Input
—	—	12	14	10	12	INC+	Amplifier C Noninverting Input
—	—	—	—	14	16	OUTD	Amplifier D Output
—	—	—	—	13	15	IND-	Amplifier D Inverting Input
—	—	—	—	12	14	IND+	Amplifier D Noninverting Input
—	—	—	—	—	—	EN	Enable Amplifier
—	—	1	1	—	—	ENA	Enable Amplifier A
—	—	3	3	—	—	ENB	Enable Amplifier B
—	—	2	2	—	—	ENC	Enable Amplifier C

MAX4012/MAX4016/MAX4018/MAX4020

# Low-Cost, High-Speed, SOT23, Single-Supply Op Amps with Rail-to-Rail Outputs

## Detailed Description

The MAX4012/MAX4016/MAX4018/MAX4020 are single-supply, rail-to-rail, voltage-feedback amplifiers that employ current-feedback techniques to achieve 600V/μs slew rates and 200MHz bandwidths. Excellent harmonic distortion and differential gain/phase performance make these amplifiers an ideal choice for a wide variety of video and RF signal-processing applications.

The output voltage swing comes to within 50mV of each supply rail. Local feedback around the output stage assures low open-loop output impedance to reduce gain sensitivity to load variations. This feedback also produces demand-driven current bias to the output transistors for ±120mA drive capability, while constraining total supply current to less than 7mA. The input stage permits common-mode voltages beyond the negative supply and to within 2.25V of the positive supply rail.

## Applications Information

### Choosing Resistor Values

#### Unity-Gain Configuration

The MAX4012/MAX4016/MAX4018/MAX4020 are internally compensated for unity gain. When configured for unity gain, the devices require a 24Ω resistor (R<sub>F</sub>) in series with the feedback path. This resistor improves AC response by reducing the Q of the parallel LC circuit formed by the parasitic feedback capacitance and inductance.

cuit formed by the parasitic feedback capacitance and inductance.

#### Inverting and Noninverting Configurations

Select the gain-setting feedback (R<sub>F</sub>) and input (R<sub>G</sub>) resistor values to fit your application. Large resistor values increase voltage noise and interact with the amplifier's input and PC board capacitance. This can generate undesirable poles and zeros and decrease bandwidth or cause oscillations. For example, a noninverting gain-of-two configuration (R<sub>F</sub> = R<sub>G</sub>) using 1kΩ resistors, combined with 1pF of amplifier input capacitance and 1pF of PC board capacitance, causes a pole at 159MHz. Since this pole is within the amplifier bandwidth, it jeopardizes stability. Reducing the 1kΩ resistors to 100Ω extends the pole frequency to 1.59GHz, but could limit output swing by adding 200Ω in parallel with the amplifier's load resistor. Table 1 shows suggested feedback, gain resistors, and bandwidth for several gain values in the configurations shown in Figures 1a and 1b.

#### Layout and Power-Supply Bypassing

These amplifiers operate from a single +3.3V to +11V power supply or from dual supplies to ±5.5V. For single-supply operation, bypass V<sub>CC</sub> to ground with a 0.1μF capacitor as close to the pin as possible. If operating with dual supplies, bypass each supply with a 0.1μF capacitor.

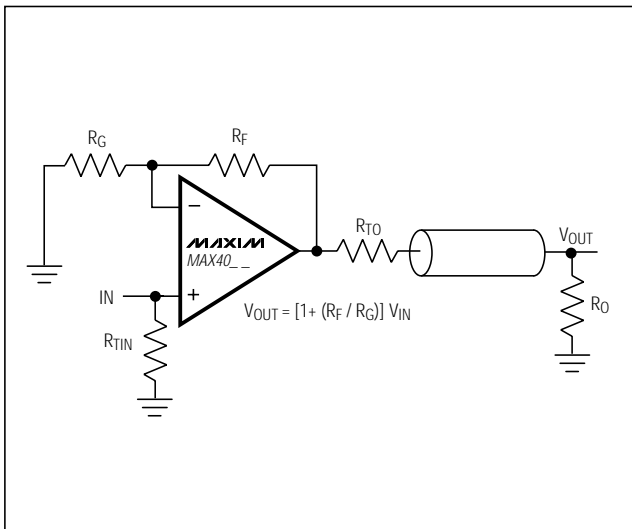

Figure 1a. Noninverting Gain Configuration

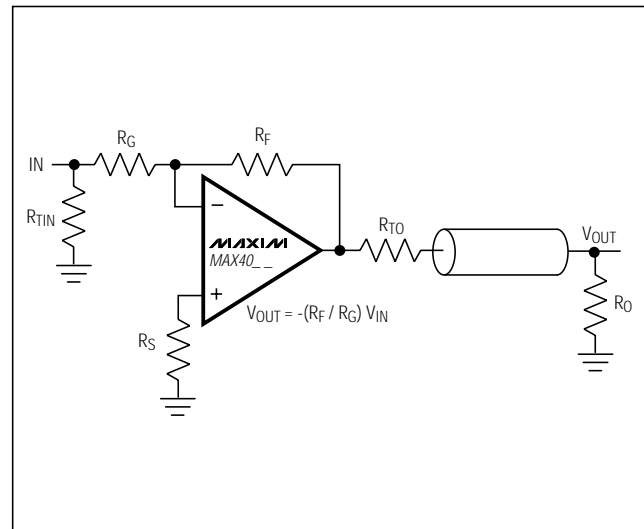

Figure 1b. Inverting Gain Configuration

# Low-Cost, High-Speed, SOT23, Single-Supply Op Amps with Rail-to-Rail Outputs

MAX4012/MAX4016/MAX4018/MAX4020

Maxim recommends using microstrip and stripline techniques to obtain full bandwidth. To ensure that the PC board does not degrade the amplifier's performance, design it for a frequency greater than 1GHz. Pay careful attention to inputs and outputs to avoid large parasitic capacitance. Whether or not you use a constant-impedance board, observe the following guidelines when designing the board:

- Don't use wire-wrap boards because they are too inductive.
- Don't use IC sockets because they increase parasitic capacitance and inductance.
- Use surface-mount instead of through-hole components for better high-frequency performance.
- Use a PC board with at least two layers; it should be as free from voids as possible.
- Keep signal lines as short and as straight as possible. Do not make 90° turns; round all corners.

### Rail-to-Rail Outputs, Ground-Sensing Input

The input common-mode range extends from (V<sub>EE</sub> - 200mV) to (V<sub>CC</sub> - 2.25V) with excellent common-mode rejection. Beyond this range, the amplifier output is a nonlinear function of the input, but does not undergo phase reversal or latchup.

The output swings to within 60mV of either power-supply rail with a 2kΩ load. The input ground-sensing and the rail-to-rail output substantially increase the dynamic range. With a symmetric input in a single +5V application, the input can swing 2.95Vp-p, and the output can swing 4.9Vp-p with minimal distortion.

### Enable Input and Disabled Output

The enable feature (EN<sub>L</sub>) allows the amplifier to be placed in a low-power, high-output-impedance state. Typically, the EN<sub>L</sub> logic low input current (I<sub>IL</sub>) is small. However, as the EN voltage (V<sub>IL</sub>) approaches the negative supply rail, I<sub>IL</sub> increases (Figure 2). A single resistor connected as shown in Figure 3 prevents the rise in the logic-low input current. This resistor provides a feedback mechanism that increases V<sub>IL</sub> as the logic input is brought to V<sub>EE</sub>. Figure 4 shows the resulting input current (I<sub>IL</sub>).

When the MAX4018 is disabled, the amplifier's output impedance is 35kΩ. This high resistance and the low 2pF output capacitance make this part ideal in RF/video multiplexer or switch applications. For larger arrays, pay careful attention to capacitive loading. See the *Output Capacitive Loading and Stability* section for more information.

**Table 1. Recommended Component Values**

COMPONENT	GAIN (V/V)									
	+1	-1	+2	-2	+5	-5	+10	-10	+25	-25
R <sub>F</sub> (Ω)	24	500	500	500	500	500	500	500	500	1200
R <sub>G</sub> (Ω)	∞	500	500	250	124	100	56	50	20	50
R <sub>S</sub> (Ω)	—	0	—	0	—	0	—	0	—	0
R <sub>TIN</sub> (Ω)	49.9	56	49.9	62	49.9	100	49.9	∞	49.9	∞
R <sub>TO</sub> (Ω)	49.9	49.9	49.9	49.9	49.9	49.9	49.9	49.9	49.9	49.9
Small-Signal -3dB Bandwidth (MHz)	200	90	105	60	25	33	11	25	6	10

**Note:** R<sub>L</sub> = R<sub>O</sub> + R<sub>TO</sub>; R<sub>TIN</sub> and R<sub>TO</sub> are calculated for 50Ω applications. For 75Ω systems, R<sub>TO</sub> = 75Ω; calculate R<sub>TIN</sub> from the following equation:

$$R_{TIN} = \frac{75}{1 - \frac{75}{R_G}} \Omega$$

# Low-Cost, High-Speed, SOT23, Single-Supply Op Amps with Rail-to-Rail Outputs

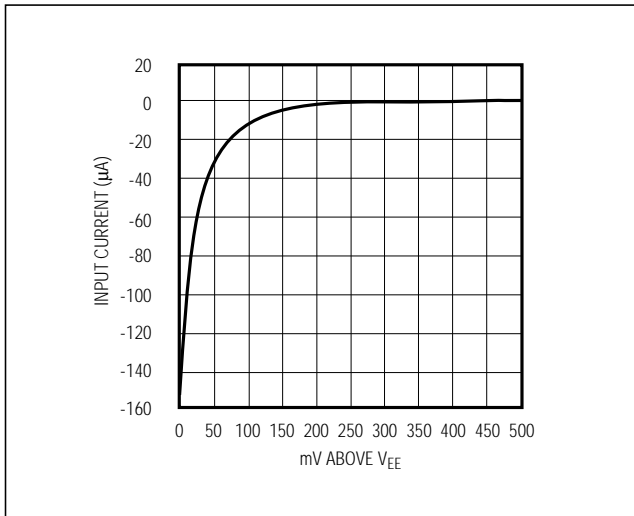

Figure 2. Enable Logic-Low Input Current vs.  $V_{IL}$

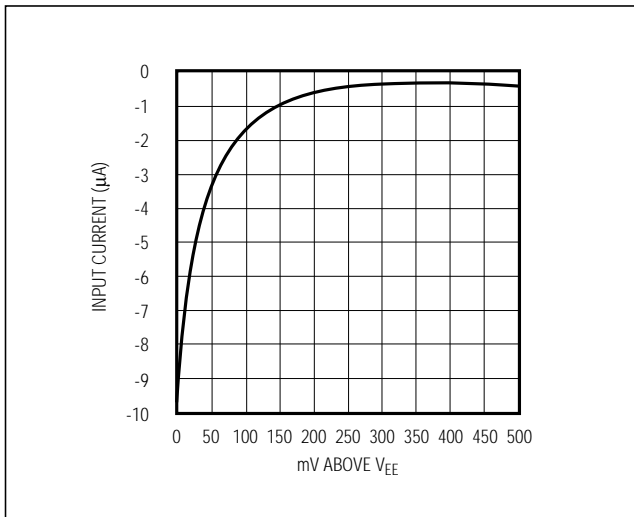

Figure 4. Enable Logic-Low Input Current vs.  $V_{IL}$  with 10kΩ Series Resistor

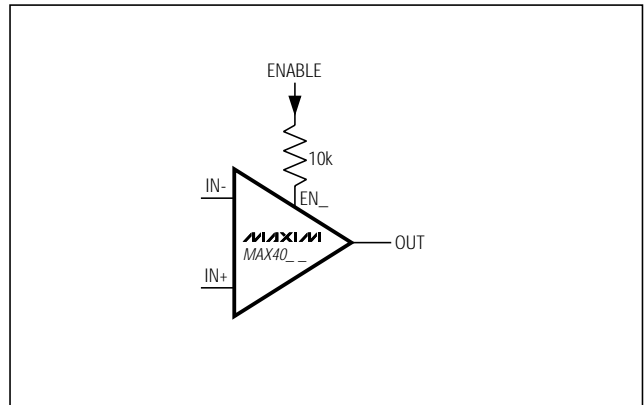

Figure 3. Circuit to Reduce Enable Logic-Low Input Current

To implement the mux function, the outputs of multiple amplifiers can be tied together, and only the amplifier with the selected input will be enabled. All of the other amplifiers will be placed in the low-power shutdown mode, with their high output impedance presenting very little load to the active amplifier output. For gains of +2 or greater, the feedback network impedance of all the amplifiers used in a mux application must be considered when calculating the total load on the active amplifier output

### Output Capacitive Loading and Stability

The MAX4012/MAX4016/MAX4018/MAX4020 are optimized for AC performance. They are not designed to drive highly reactive loads, which decreases phase margin and may produce excessive ringing and oscillation. Figure 5 shows a circuit that eliminates this problem. Figure 6 is a graph of the optimal isolation resistor ( $R_s$ ) vs. capacitive load. Figure 7 shows how a capacitive load causes excessive peaking of the amplifier's frequency response if the capacitor is not isolated from the amplifier by a resistor. A small isolation resistor (usually 20Ω to 30Ω) placed before the reactive load prevents ringing and oscillation. At higher capacitive loads, AC performance is controlled by the interaction of the load capacitance and the isolation resistor. Figure 8 shows the effect of a 27Ω isolation resistor on closed-loop response.

Coaxial cable and other transmission lines are easily driven when properly terminated at both ends with their characteristic impedance. Driving back-terminated transmission lines essentially eliminates the line's capacitance.

# Low-Cost, High-Speed, SOT23, Single-Supply Op Amps with Rail-to-Rail Outputs

MAX4012/MAX4016/MAX4018/MAX4020

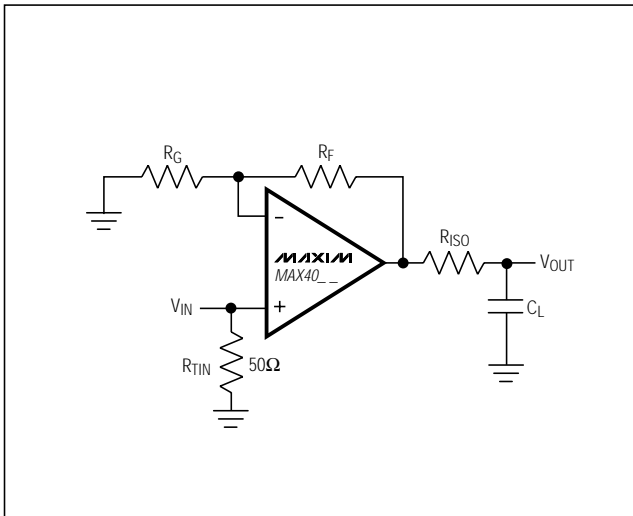

Figure 5. Driving a Capacitive Load through an Isolation Resistor

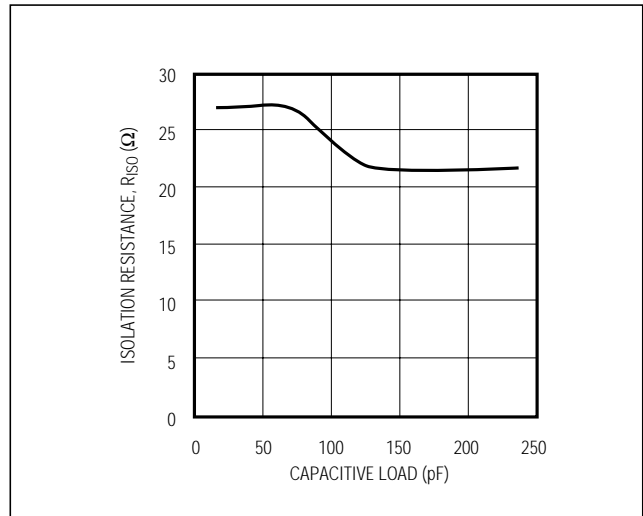

Figure 6. Capacitive Load vs. Isolation Resistance

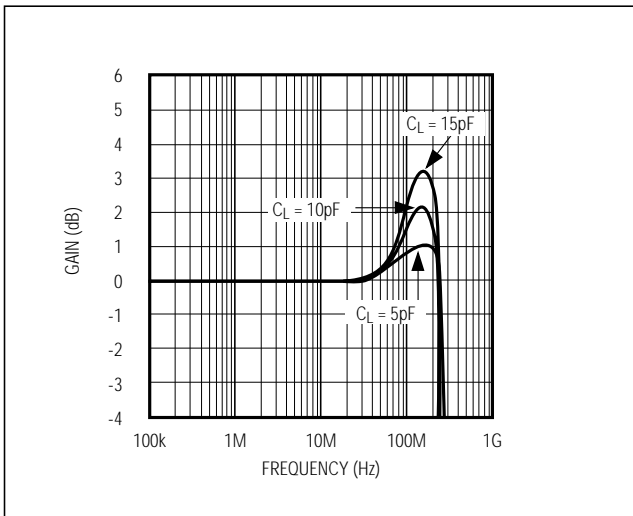

Figure 7. Small-Signal Gain vs. Frequency with Load Capacitance and No Isolation Resistor

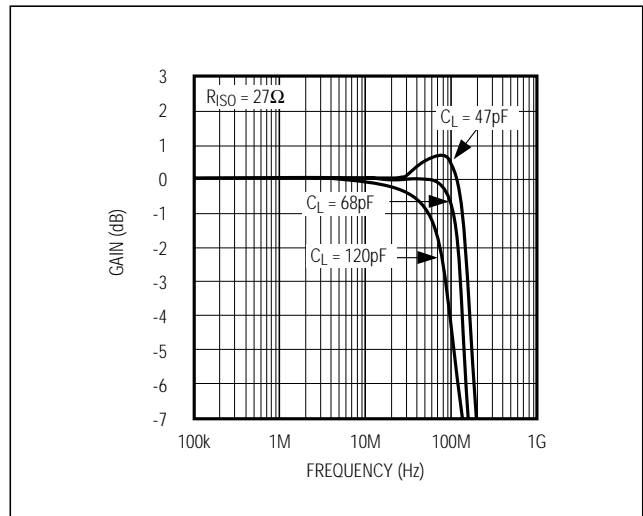
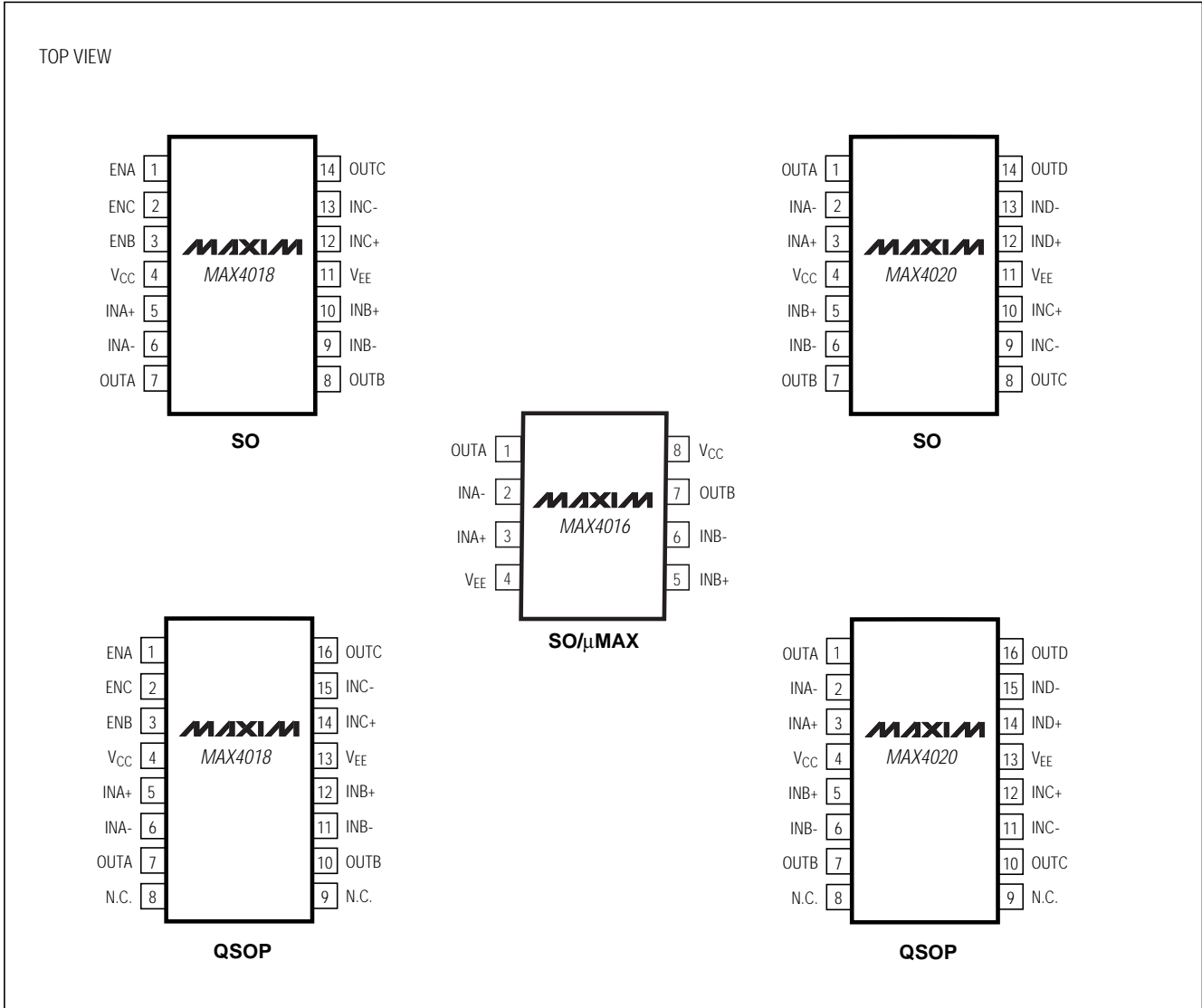

Figure 8. Small-Signal Gain vs. Frequency with Load Capacitance and 27Ω Isolation Resistor

# Low-Cost, High-Speed, SOT23, Single-Supply Op Amps with Rail-to-Rail Outputs

Pin Configurations (continued)



# Low-Cost, High-Speed, SOT23, Single-Supply Op Amps with Rail-to-Rail Outputs

## Ordering Information (continued)

PART	TEMP. RANGE	PIN-PACKAGE	SOT TOP MARK
MAX4018ESD	-40°C to +85°C	14 SO	—
MAX4018EEE	-40°C to +85°C	16 QSOP	—
MAX4020ESD	-40°C to +85°C	14 SO	—
MAX4020EEE	-40°C to +85°C	16 QSOP	—

## Chip Information

PART	TRANSISTOR COUNT
MAX4012	95
MAX4016	190
MAX4018	299
MAX4020	362

MAX4012/MAX4016/MAX4018/MAX4020

## Package Information

SYMBOL	MIN	MAX
A	0.90	1.45
A1	0.00	0.15
A2	0.90	1.30
b	0.35	0.50
C	0.08	0.20
D	2.80	3.00
E	2.60	3.00
E1	1.50	1.75
L	0.35	0.55
e	0.95 REF	
e1	1.90 REF	
α	0°	10°

NOTE:

- ALL DIMENSIONS ARE IN MILLIMETERS.
- FOOT LENGTH MEASURED AT INTERCEPT POINT BETWEEN DATUM A & LEAD SURFACE.
- PACKAGE OUTLINE EXCLUSIVE OF MOLD FLASH & METAL BURR.
- PACKAGE OUTLINE INCLUSIVE OF SOLDER PLATING.

MAXIM  
 PROPRIETARY INFORMATION  
 TITLE: PACKAGE OUTLINE, SOT23, 5L  
 APPROVAL: \_\_\_\_\_ DOCUMENT CONTROL NO: 21-0057 REV: B 1/1

# Low-Cost, High-Speed, SOT23, Single-Supply Op Amps with Rail-to-Rail Outputs

Package Information (continued)

DIM	INCHES		MILLIMETERS	
	MIN	MAX	MIN	MAX
A	0.036	0.044	0.91	1.11
A1	0.004	0.008	0.10	0.20
B	0.010	0.014	0.25	0.36
C	0.005	0.007	0.13	0.18
D	0.116	0.120	2.95	3.05
e	0.0256		0.65	
E	0.116	0.120	2.95	3.05
H	0.188	0.198	4.78	5.03
L	0.016	0.026	0.41	0.66
α	0°	6°	0°	6°

NOTES:  
 1. D & E DO NOT INCLUDE MOLD FLASH.  
 2. MOLD FLASH OR PROTRUSIONS NOT TO EXCEED .15mm(.006").  
 3. CONTROLLING DIMENSION: INCHES

MAXIM PROPRIETARY INFORMATION  
 TITLE: 8LD UMAX PACKAGE OUTLINE DWG.  
 APPROVAL: DOCUMENT CONTROL NO: 21-0036 REV: D 1/1

DIM	INCHES		MILLIMETERS	
	MIN	MAX	MIN	MAX
A	.061	.068	1.55	1.73
A1	.004	.0098	0.127	0.25
A2	.055	.061	1.40	1.55
B	.008	.012	0.20	0.31
C	.0075	.0098	0.19	0.25
D	SEE VARIATIONS			
E	.150	.157	3.81	3.99
e	.025 BSC		0.635 BSC	
H	.230	.244	5.84	6.20
h	.010	.016	0.25	0.41
L	.016	.035	0.41	0.89
N	SEE VARIATIONS			
S	SEE VARIATIONS			
?	0°	8°	0°	8°

VARIATIONS:

DIM	INCHES		MILLIMETERS		N
	MIN.	MAX.	MIN.	MAX.	
D	.189	.196	4.80	4.98	16 AA
S	.0020	.0070	0.05	0.18	
D	.337	.344	8.56	8.74	20 AB
S	.0500	.0550	1.27	1.40	
D	.337	.344	8.56	8.74	24 AC
S	.0250	.0300	0.64	0.76	
D	.386	.393	9.80	9.98	28 AD
S	.0250	.0300	0.64	0.76	

NOTES:  
 1. D & E DO NOT INCLUDE MOLD FLASH OR PROTRUSIONS  
 2. MOLD FLASH OR PROTRUSIONS NOT TO EXCEED .006"  
 3. CONTROLLING DIMENSIONS: INCHES

MAXIM PROPRIETARY INFORMATION  
 TITLE: PACKAGE OUTLINE, QSDP, .150 INCH, .025" LEAD PITCH  
 APPROVAL: DOCUMENT CONTROL NO: 21-0055 REV: A 1/1

Maxim cannot assume responsibility for use of any circuitry other than circuitry entirely embodied in a Maxim product. No circuit patent licenses are implied. Maxim reserves the right to change the circuitry and specifications without notice at any time.

16 Maxim Integrated Products, 120 San Gabriel Drive, Sunnyvale, CA 94086 408-737-7600